



Gear Testing Instruments with Face Stop

Measurement of the dimension between or over two balls



FRENCO

Measuring with Face Stop

VP gear testing instruments feature a face stop. Finding the reversal point is no longer required.

Specimens with a usable end face are placed on the table of the instrument and measured at right-angles without reversal point.

The measuring stilts of the VP instruments can be rotated and moved. They are universally suitable for both internal and external profiles with small or large diameters.

A **setting plug or ring** is needed for calibration. The spline or gear profile has to equal the specimen.

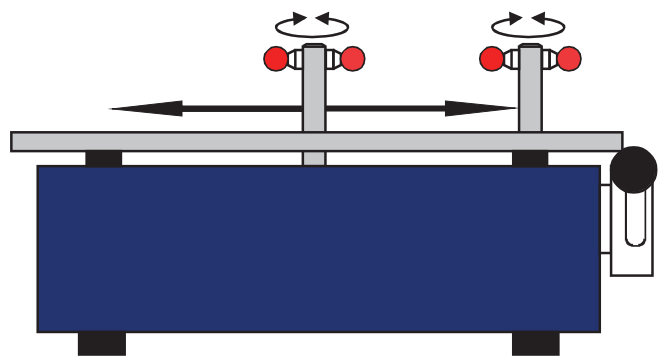
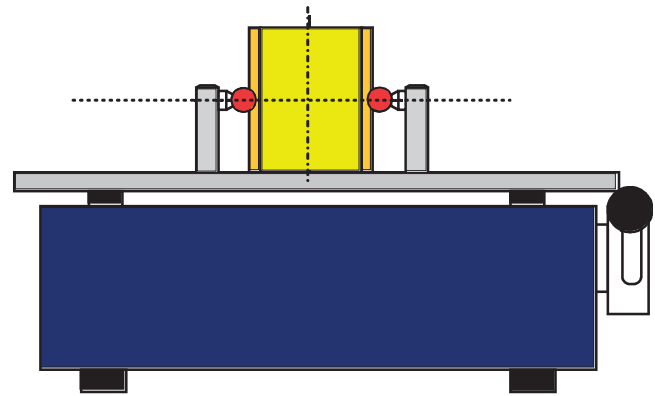







Features:





- The measuring results are not reliant on the operator.
- Measurements are always carried out at right-angles to the work-piece axis.
- Different sizes, types and diameters of gears and splines can be measured with one instrument.
- Measuring helical profiles is possible.
- Wear of the measuring inserts can be compensated for through calibrations with a setting master.
- Measurement is possible in any number of planes (VPE only).

Product Overview

	Type & Picture	Pitch circle diameter
VPO		External gear up to 100 mm Internal gear 18mm up to 120 mm
VPE		External gear up to 200 mm Internal gear 18mm up to 220 mm
VPOS		For shafts with external gearing up to 250 mm
VPO3		External gear up to 250 mm Internal gear 90 mm to 320 mm

Measured value display		Analogue dial indicator
		digital
Radial measuring points	 or 	Two opposite-lying for inside and outside
Axial measuring planes		static
		dynamic

Gear Testing Instrument VPO

Measured value display	Radial measuring points	Axial measuring planes
		
		

The VPO is a simple gear testing machine to determine the diametrical size over two balls in **one** specific measuring plane. It can be refitted within a few minutes and is particularly suitable for quick measurements of small pieces up to a PCD of 120 mm.







The balls are mounted on a movable and a fixed carriage. To change the workpiece, the movable carriage can be retracted using the lever on the front. To display the measuring results both a dial indicator or a digital probe can be used.



Gear testing instrument VPO

Technical specifications VPO	
External gears	up to 100 mm PCD
Internal gears	18 mm up to 120 mm PCD
Measuring force	infinitely adjustable up to 10 N
Dimensions (without stilts)	185x180x58 mm
Weight approx.	3.3 kg

Gear Testing Instrument VPE

Measured value display	Radial measuring points	Axial measuring planes
		
		

The VPE is a gear testing machine to determine the diametrical size over two balls in any number of planes. It can be refitted within a few minutes and is mainly used for quick measurements of pieces with a PCD up to approx. 220 mm.



Measuring device VPE

Technical specifications	
External gears	up to 200 mm PCD
Internal gears	18 mm up to 220 mm PCD
Vertical travel	30 mm
Measuring force	infinitely adjustable up to 10 N
Dimensions (without stilts)	340x210x118 mm
Weight approx.	11 kg

Gear Testing Instrument VPOS

Measured value display	Radial measuring points	Axial measuring planes

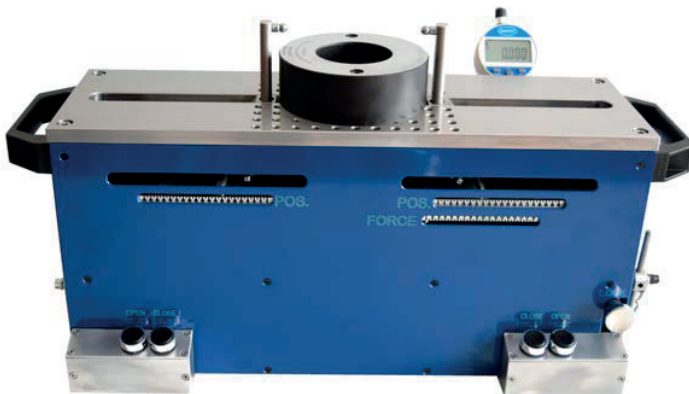

The VPOS instrument was designed to measure the dimension over/between balls on large workpieces and splined shafts.

Great importance was given to functionality, optical characteristic and easy handling to ensure that, besides precision and accuracy, a comprehensive objective was achieved. The positioning of the stilts is performed pneumatically, and the feed mechanically dampened. To increase safety, the device can be operated in two-hand mode. The measuring force can be adjusted to the workpiece weight quickly and easily via the lever.

The VPOS is easy to operate and a stable table-top instrument to be used on the shop floor



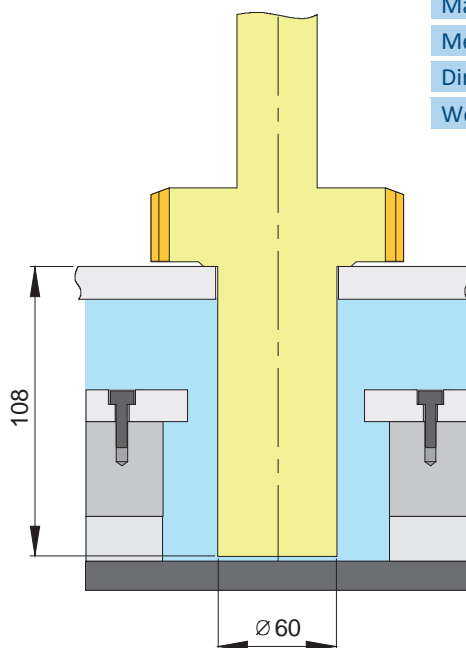

Technical Specifications	
External gears	Dimension over balls: 75 - 260 mm
Max. shaft diameter	up to $\varnothing 60$ mm (in standard version)
Max. shaft shoulder length	up to 108 mm (extendable)
Measuring force	infinitely adjustable up to 15 N
Dimension (without stilts)	340x210x118 mm
Weight approx.	25 kg



Lever to infinitely adjust the measuring force



Gear Testing Instrument VPO3

Measured value display	Radial measuring points	Axial measuring planes
		
		

Gear testing instrument VPO3

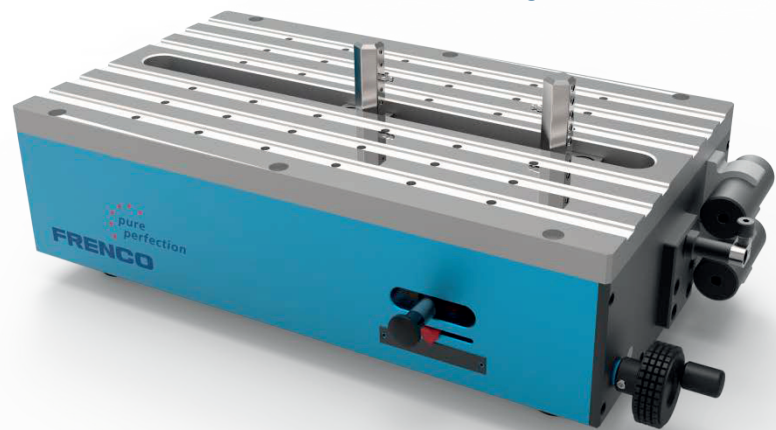













Our new device for the manual measurement of the dimension over balls DOB of large workpieces.

- Reduction of the measuring force by tilting the device
- Holding position of the measuring stilts for easy loading and unloading
- Metro Touch Display for quick results and PC interface for data export
- Integration of a thermostat possible

Technical Specifications	
DOB external gears	ca. 0 - 250 mm
DOB internal gears	ca. 90 - 320 mm
Measuring force	5 - 20 N
Measuring pin threads	M2,5 oder M4
Dimensions (without stilts and measuring probe)	360 mm x 200 mm x 110 mm
Weight	20 kg

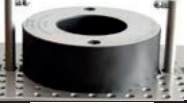
Accessories

Stilts 35 mm for measuring ball inserts M2.5 or M4 or for Mahr inserts	
Stilts 60 mm for measuring ball inserts M2.5 or M4 or for Mahr inserts	
Stilts 35 mm for measuring pin inserts	
Stilts 60 mm for measuring ball inserts	
Measuring ball inserts tungsten carbide available in 1 micron steps, with M2.5 (from Ø1-7 mm) or M4 thread (from Ø7 mm)	
Measuring pin inserts, rocking and rotating	
Stop prisms for easier mounting of workpieces	
FRENCO dial indicator with eccentric zero point	
Probe with "Heidenhain" display	
Setting rings and plugs	
Centering support	
Setting master for measuring height	

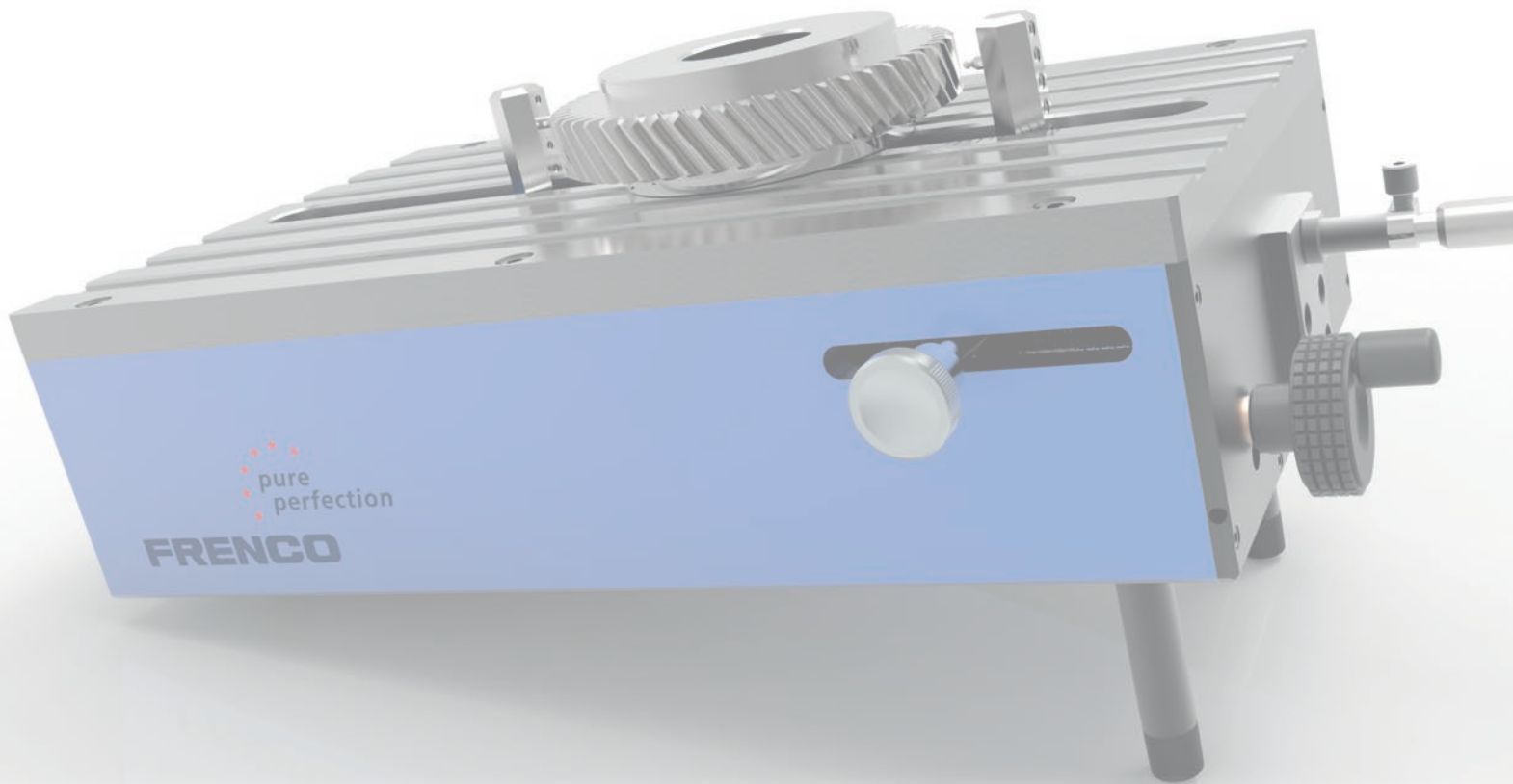

Pure Perfection. Since 1978.

Experience, competence and innovation in gear metrology.



Our Products:

Spline Gauges | Toothed Artefacts and Masters | Master Gears |
Tools and Clamping Systems | Size Inspection Instruments |
Double Flank Gear Inspection | Gear Flank Analyser | Universal
Measuring Machines | Rack Inspection Machines | Software

Our Services:

DAKKS Calibration | Gear and Spline Inspection |
Gear and Spline Manufacturing | Seminars | Service |
Support and Calculation

Phone: +49 (0) 9187 95 22 0

FRESCO GmbH

Gear + Spline Technology

Jakob-Baier-Str. 3 • D - 90518 Altdorf

www.fresco.com



FRESCO